

INSTALLATION GUIDE

Draw wire sensors series SX135

For further information please see the data sheet at www.waycon.biz/products/draw-wire-sensors

FIRST STEPS

WayCon Positionsmesstechnik GmbH would like to thank you for the trust you have placed in us and our products. This manual will make you familiar with the installation and operation of our draw wire sensors. Please read this manual carefully before initial operation!

Unpacking and checking:

Carefully lift the device out of the box by grabbing the housing. Do not pull the rope. After unpacking the device, check it for any visible damage as a result of rough handling during the shipment. Check the delivery for completeness.

If necessary consult the transportation company, or contact WayCon directly for further assistance.

MOUNTING OF THE SENSOR

- Mount the sensor at the designated place, before extracting the rope and before attaching the rope to the measuring target.
- The sensor can be installed in two ways, by using the supplied T-slot nuts, or the clamp brackets. You will find a detailed description of both installation methods in the next section.
- Open the rope clip after the sensor is fully mounted and carefully extract the measuring rope. Hook the rope clip on the measuring target and close the bracket of the clip. For safety reasons put a screw driver trough the clip to extract the rope.

HANDLING THE WIRE ROPE

- When installing or operating the sensor, take care not to let the rope snap back by mistake or extract the rope over the specified measurement range, as this might destroy the sensor.
- The rope must be extracted from the sensor vertically. The maximum variation from the vertical is 3°. Avoid extracting the rope at an inclination, since the durability of the instrument would shorten considerably. If it is not possible to keep the limit of 3°, a deflection pulley has to be used.
- Guide the rope preferably in corners or guarded in channels to prevent pollution or accidental touch.
- Avoid guiding the rope over edges or corners. Use a deflection pulley instead.
- Do not operate the sensor if the rope is buckled or damaged. A ripping of the rope may lead to injuries or a damaging of the sensor.

MOUNTING

1. Mounting via T-slot nuts

The included T-slot nuts can be easily inserted into the grooves of the sensor housing. The nuts have a metric thread M6.

Two (up to 20 m measurement range) or four (more than 25 m measurement range) T-slot nuts are included in the delivery.

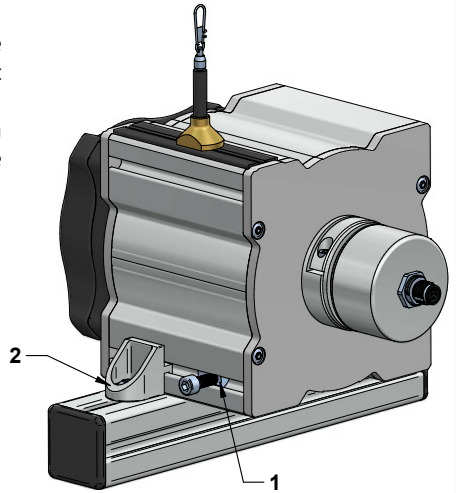
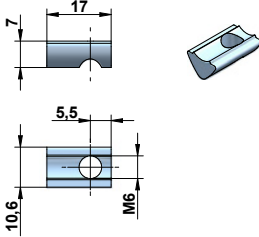

2. Mounting via angle clamp brackets

The angle clamp brackets feature a bore for M6 screws to fix it on a plate, slab or a profile.

Two (up to 20 m measurement range) or four (more than 25 m measurement range) angle clamp brackets are included in the delivery.

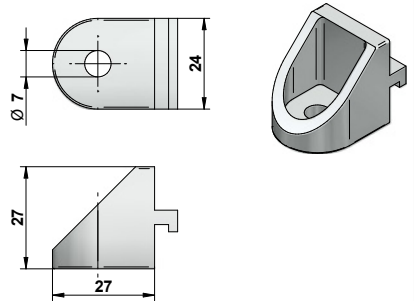

Position of the grooves and angle clamp brackets

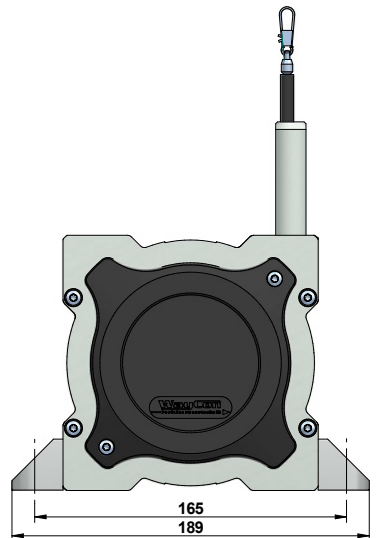
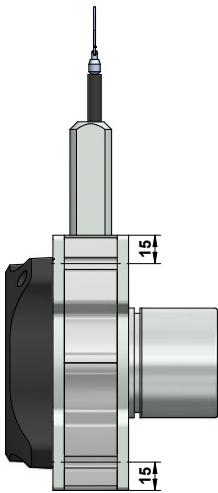

ELECTRICAL CONNECTION ANALOG OUTPUT

Cable output cable colours	Connector output M12, male	Potentiometer output	Voltage output	Current output	Voltage output (teachable)
BN	Pin 1	+V	+V	+V	+V
WH	Pin 2	Cursor	Signal	n. c.	Signal
BU	Pin 3	GND	GND	Signal	GND
BK	Pin 4	n. c.	GND _{Signal}	n. c.	MFL *

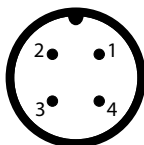

* Multi-functional line

ELECTRICAL CONNECTION INCREMENTAL OUTPUT

Connector output M12, male, 8 pins

Signal	GND	+V	A	/A	B	/B	Z	/Z
Pin	1	2	3	4	5	6	7	8

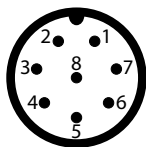

Connector output M23, male, 12 pins

Signal	GND	+V	A	/A	B	/B	Z	/Z	GND _{sens} *	+V _{sens} *	n. c.
Pin	10	12	5	6	8	1	3	4	11	2	7, 9

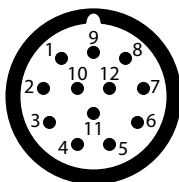

Cable output (Line Driver 10 poles, Push-Pull 8 poles)

Signal	GND	+V	A	/A	B	/B	Z	/Z	GND _{sens} *	+V _{sens} *
Pin	WH	BN	GN	YE	GY	PK	BU	RD	BK	VT

* only for Line Driver (order code L)

ELECTRICAL CONNECTION SSI

Cable output ¹⁾

Signal	GND	+V	C+	C-	D+	D-	SET	DIR	Status	H
Cable colour	WH	BN	GN	YE	GY	PK	BU	RD	BK	shield

¹⁾ isolate unused wires individually before initial start-up

Connector output M12, male, 8 pins

Signal	GND	+V	C+	C-	D+	D-	SET	DIR	H
Pin	1	2	3	4	5	6	7	8	shield



Connector output M23, male, 12 pins

Signal	GND	+V	C+	C-	D+	D-			
Pin	1	2	3	4	5	6			
Signal	SET	DIR	Status	n. c.		H			
Pin	7	8	9	10, 11, 12		shield			

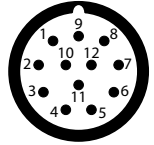

ELECTRICAL CONNECTION CAN_{OPEN}

2 x Connector output M12

	Bus OUT (female)					Bus IN (male)				
Signal	GND	+V	CAN_L	CAN_H	CAN_GND	GND	+V	CAN_L	CAN_H	CAN_GND
Pin	3	2	5	4	1	3	2	5	4	1

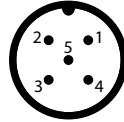
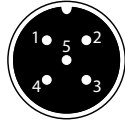

Cable gland radial (removable bus terminal cover)

	Bus OUT					Bus IN				
Signal	GND	+V	CAN_L	CAN_H	CAN_GND	GND	+V	CAN_L	CAN_H	CAN_GND
Acronym	0V	+V	CL	CH	CG	0V	+V	CL	CH	CG

¹⁾ isolate unused wires individually before initial start-up

ELECTRICAL CONNECTION PROFIBUS

Cable gland radial (removable bus terminal cover)

	Bus IN				Bus OUT			
Signal	B	A	GND	+V	GND	+V	B	A
Terminal	1	2	3	4	5	6	7	8

The shield of the connection cable must be connected over a large area via the cable gland.

3 x Connector output M12

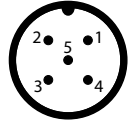
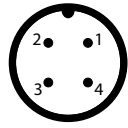
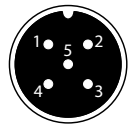
Bus IN (male)	Signal	n. c.	PB_A	n. c.	PB_B	shield	
	Pin	1	2	3	4	5	
Power supply (male)	Signal	+V	n. c.	GND	n. c.	-	
	Pin	1	2	3	4	-	
Bus OUT (female)	Signal	BUS_VDC ¹⁾	PB_A	BUS_GND ¹⁾	PB_B	shield	
	Pin	1	2	3	4	5	

¹⁾ for supplying an external Profibus termination resistor

ELECTRICAL CONNECTION EtherCAT, PROFINET

3 x Connector output M12

Bus IN or Bus 1	Signal	Transmit data +	Receive data +	Transmit data -	Receive data -
	Acronym	TxD+	RxD+	TxD-	RxD-
	Pin	1	2	3	4
Power supply	Signal	Voltage +	n. c.	Voltage -	n. c.
	Acronym	+V	n. c.	0 V	n. c.
	Pin	1	2	3	4
Bus OUT or Bus 2	Signal	Transmit data +	Receive data +	Transmit data -	Receive data -
	Acronym	TxD+	RxD+	TxD-	RxD-
	Pin	1	2	3	4

Bus IN D-coded (female)

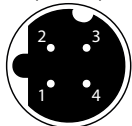

Power supply (male)

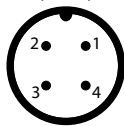

Bus OUT D-coded (female)

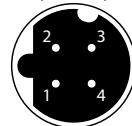

ACCESSORIES CABLE

Analog output and power supply Profibus, EtherCat and Profinet

Cable with mating connector M12 (female), 4 poles

K4P2M-S-M12	2 m, straight connector, IP67, shielded
K4P5M-S-M12	5 m, straight connector, IP67, shielded
K4P10M-S-M12	10 m, straight connector, IP67, shielded
K4P2M-SW-M12	2 m, angular connector, IP67, shielded
K4P5M-SW-M12	5 m, angular connector, IP67, shielded
K4P10M-SW-M12	10 m, angular connector, IP67, shielded

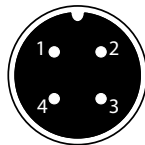

Pin	Cable colour
1	BN
2	WH
3	BU
4	BK

Incremental output

Cable with mating connector M12 (female), 8 poles

K8P2M-S-M12	2 m, straight connector, IP67, shielded
K8P5M-S-M12	5 m, straight connector, IP67, shielded
K8P10M-S-M12	10 m, straight connector, IP67, shielded
K8P2M-SW-M12	2 m, angular connector, IP67, shielded
K8P5M-SW-M12	5 m, angular connector, IP67, shielded
K8P10M-SW-M12	10 m, angular connector, IP67, shielded

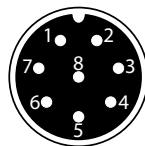

Pin	1	2	3	4	5	6	7	8
Cable colour	WH	BN	GN	YE	GY	PK	BU	RD

Cable with mating connector M23 (female), 12 poles

K12P2M-S-M23	2 m, straight connector, IP67, shielded
K12P5M-S-M23	5 m, straight connector, IP67, shielded
K12P10M-S-M23	10 m, straight connector, IP67, shielded
K12P2M-SW-M23	2 m, angular connector, IP67, shielded
K12P5M-SW-M23	5 m, angular connector, IP67, shielded
K12P10M-SW-M23	10 m, angular connector, IP67, shielded

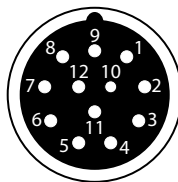

Pin	1	2	3	4	5	6	7	8	9	10	11	12
Cable colour	PK	RD-BU	BU	RD	GN	YE	-	GY	-	WH	GY-PK	BN

Digital output SSI:

Cable with mating connector M12 (female), 8 poles

K8P2M-S-M12	2 m, straight connector, IP67, shielded
K8P5M-S-M12	5 m, straight connector, IP67, shielded
K8P10M-S-M12	10 m, straight connector, IP67, shielded
K8P15M-S-M12	15 m, straight connector, IP67, shielded

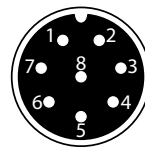

Pin	1	2	3	4	5	6	7	8
Cable colour	WH	BN	GN	YE	GY	PK	BU	RD

ACCESSORIES CABLE

Digital output SSI:

Cable with mating connector M23 (female), 12 poles

K12P02M-S-M23-SSI	2 m, straight connector, shielded
K12P05M-S-M23-SSI	5 m, straight connector, shielded
K12P10M-S-M23-SSI	10 m, straight connector, shielded
K12P15M-S-M23-SSI	15 m, straight connector, shielded

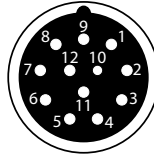

Pin	1	2	3	4	5	6	7	8	9	10	11	12
Cable colour	WH	BN	GN	YE	GY	PK	BU	RD	BK	VT	GY-PK	RD-BU

Digital output CANopen:

Cable with mating connector M12 (female), 5 poles

K5P2M-B-M12-CAN	2 m, straight connector, shielded
-----------------	-----------------------------------

Pin	1	2	3	4	5
Cable colour	shield	RD	BK	WH	BU

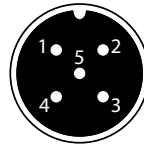

Cable with mating connector M12 (male), 5 poles

K5P2M-S-M12-CAN	2 m, straight connector, shielded
-----------------	-----------------------------------

Pin	1	2	3	4	5
Cable colour	shield	RD	BK	WH	BU

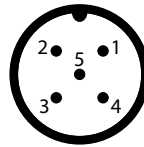

Digital output Profibus (Bus In / Bus Out):

Cable with mating connector M12 (female), 5 poles

K5P2M-B-M12-PROF	2 m, straight connector, shielded
------------------	-----------------------------------

Pin	1	2	3	4	5
Cable colour	-	GY	-	RD	-

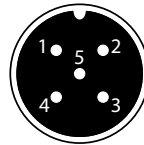

Cable with mating connector M12 (male), 5 poles

K5P2M-S-M12-PROF	2 m, straight connector, shielded
------------------	-----------------------------------

Pin	1	2	3	4	5
Cable colour	-	GY	-	RD	-

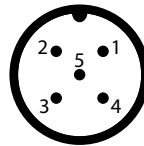

Digital output EtherCat and Profinet (Bus In / Bus Out):

Cable with mating connector M12 (female), 4 poles

K4P2M-S-M12-CAT	2 m, straight connector, shielded
K4P5M-S-M12-CAT	5 m, straight connector, shielded
K4P10M-S-M12-CAT	10 m, straight connector, shielded

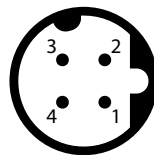

Pin	Cable colour
1	YE
2	WH
3	OG
4	BU

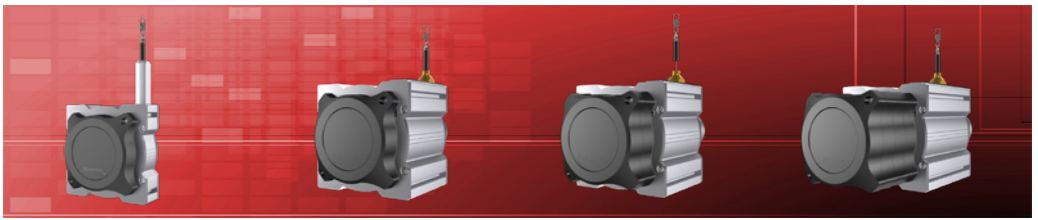

WARNING NOTICES

- Do not try to open the device. The stored energy of the spring drive may lead to injuries when being mishandled.
- Do not touch the rope when operating the sensor.
- When mounting outdoors protect the sensor and the rope from icing at temperatures below 0 °C. The usage of a deflection pulley may help defrosting the wire rope.
- When operating the sensor in a humid environment, install the sensor with the rope outlet downwards. Otherwise water will gather inside the housing, which leads to corrosion. Where applicable use option S3.

MAINTENANCE

The devices are maintenance-free. If however, the rope is soiled due to adverse environmental conditions, it can be cleaned with a cloth drenched in resin-free machine oil.

DECLARATION OF EC-CONFORMITY

Manufacturer WayCon Positionsmesstechnik GmbH
Mehlbeerenstrasse 4
82024 Taufkirchen / Germany

This is to certify that the products

Classification draw wire sensors
Product series SX

fulfill the current request of the following EC-directives:
EMC-directive 2004/108/EC (until April 19th, 2016)
2014/30/EU (from April 20th, 2016)
applied harmonized standards:
IEC 61326-1:2013

The declaration of conformity loses its validity if the product is misused or modified without proper authorisation.

Taufkirchen, 24.02.1016

Andreas Täger
CEO