

INSTALLATION GUIDE

Magnetostrictive Sensor Series MAP

For more information please see the data sheet at
www.waycon.biz/products/magnetostrictive-transducers/

FIRST STEPS

WayCon Positionsmesstechnik GmbH would like to thank you for the trust you have placed in us and our products. This manual will make you familiar with the installation and operation of our magnetostrictive sensors. Please read this manual carefully before initial operation!

Unpacking and checking:

Carefully lift the device out of the box by grabbing the housing. After unpacking the device, check it for any visible damage as a result of rough handling during the shipment. Check the delivery for completeness.

If necessary consult the transportation company, or contact WayCon directly for further assistance.

GENERAL NOTES

The transducer must be installed away from sources of magnetic fields, both static and 50 Hz (electric motors, solenoids, etc.). The sensors must be powered with non-distributed networks and always at lengths of less than 30 mt.

The transducer connection cable must be wired separately from power cables and/or solenoid controls, drives, or remote switches. The line used for power supply must be dedicated to the transducers or must be drawn directly from the power terminals and as near as possible.

The transducer's cursor is a magnet. Therefore, if there are iron filings or small magnetic metal fragments in proximity of the transducer, avoid the use of sliding cursors, as there would be a risk of material accumulation on the cursor, creating problems for sliding. Use a floating cursor instead.

MAGNETIC CURSORS

Magnetic cursors (please order separately)

Cursor	Description
PCUR220	standard version; guided sliding, axial joint, low
PCUR221	guided sliding, axial joint, high
PCUR222	guided sliding, angled joint
PCUR202	unguided floating ¹⁾

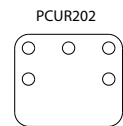
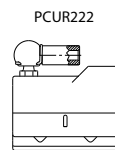
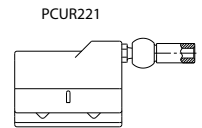
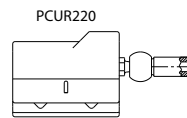

¹⁾ The adjustment has to be done 2...7 mm above the MAP-profile. Allowed lateral deviation ± 2 mm. Installation only on a support made of non-magnetic material.

MOUNTING THE SENSOR

Brackets (please order separately)

1 set includes 2 brackets. We recommend to use 1 set for each 250...300 mm of the measurement range.

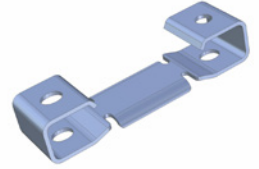

Set	Distance of bores	Screws	Length	Material
PKIT590	42.5 mm	M4	56 mm	steel
PKIT591	50 mm	M5	63.5 mm	steel

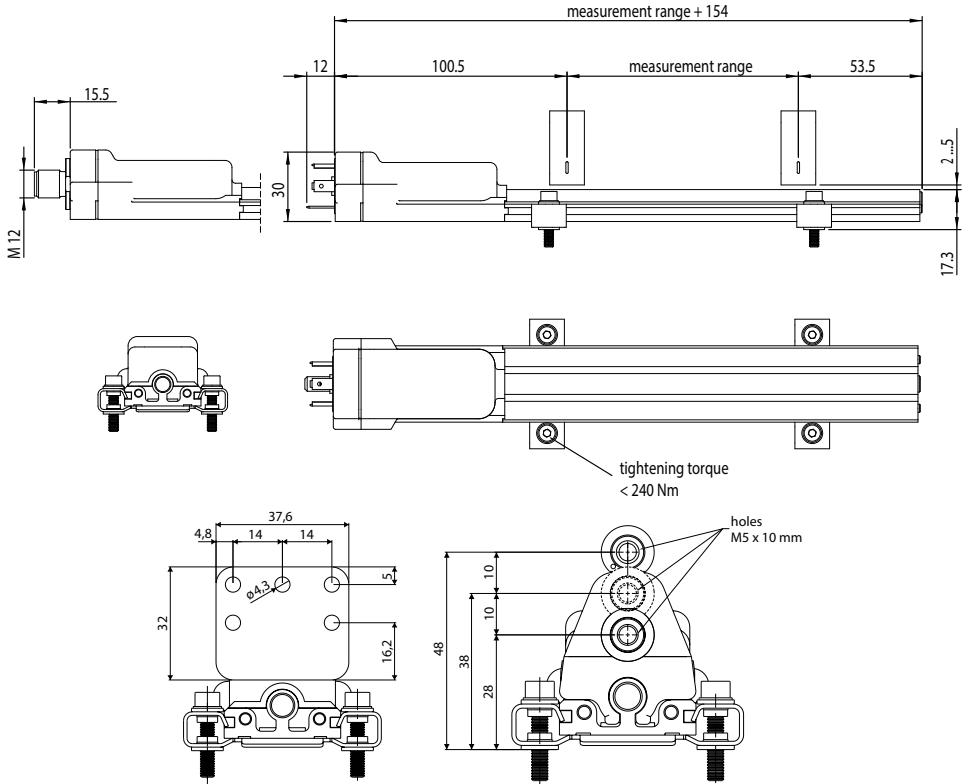

During installation, please observe the magnetically inactive range before and after the measurement range. The inactive range is 100.5 mm on the connector side and 53.5 mm on the front side (see drawing above).

ELECTRICAL CONNECTION

MAP-A-A:

Connector M12, 5 pins, male

Power supply: 24 VDC, $\pm 20\%$

Function	Pin
Signal	1
GND _{Signal}	2
n. c.	3
GND _{Supply}	4
+V	5

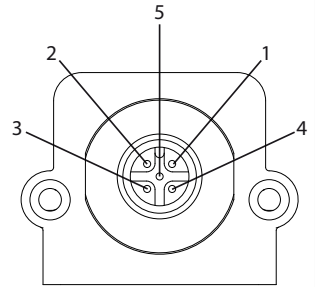

Accessory connection cable

Cable with mating connector M12, female, 5 pins, IP67

K5PXM-S-M12 | X m, straight connector, shielded

K5PXM-SW-M12 | X m, angular connector, shielded

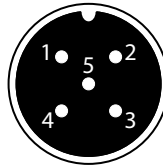

Pin	Cable colour
1	BN
2	WH
3	BU
4	BK
5	GY

MAP-A-M:

Connector EN175301-803 Form A, 4 pins, male

Power supply: 24 VDC, $\pm 20\%$

Function	Pin
+V	1
Signal	2
GND	3
Shield	4

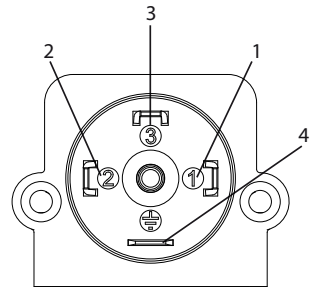

Accessory mating connector CON006

for self assembly, angular, IP65, 4 pins,
cable gland PG9 for cable diameter 6...8 mm

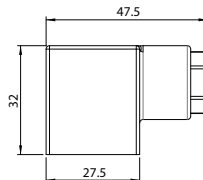



DECLARATION OF EU-CONFORMITY

WayCon Positionsmesstechnik GmbH
Mehlbeerenstrasse 4
82024 Taufkirchen / Germany

This is to certify that the products

Classification
Series

Magnetostrictive Sensors
MAP

fulfill the current request of the following EU-directives:

EMV-directive 2004/108/EG (until April 19th 2016)
 2014/30/EU (from April 20th 2016)

applied harmonized standards:

EN 61000-6-2:2005, EN 61000-6-4:2007, EN 61326-1:2006

The declaration of conformity loses its validity if the product is misused or modified without proper authorisation.

Taufkirchen, 24.02.2016

Andreas Täger
CEO